



- New function (mix mode)
- RGB composition for greatly improved color differentiation
- Simple teach function for color setting

## Type

Detection method	Detecting distance	Model	Operation mode	Output mode	Remarks
Optical fiber type	Shown as below depending on fiber optic cable	<b>CS-D3</b>	3-color teaching Single-color identification (*)	NPN open collector	Amplifier
		<b>CS-D3PN</b>		PNP open collector	
Limited reflection type	13mm (10~16mm)	<b>CS-DF10</b>	—	—	Fiber optic cable length: 2 m, free-cutting
	33mm (28~38mm)	<b>CS-DF30</b>			

- External bank selection available (\*)

A model with a separate bank changeover switch for external bank selection is also available. Model: CS-D3-01

### Pure RGB composit light for improved color differentiation

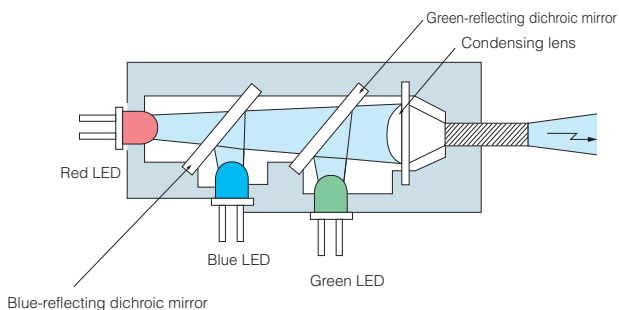

### Fiber optic cable

Standard detecting distance

- Model : CS-DF10 13mm
- Model : CS-DF30 33mm



\*Generic fiber optic cables (ø2.2) may be used as well as 2 types of special fiber optic cables.

## New! "Mix teaching" allows accurate differentiation between similar colors

This teaching method is effective for differentiation between shades with upper and lower limits and between unevenly colored work.

In addition to the differentiation adjustment that provides for tolerance between fine and coarse. An individually distinct differentiation setting is also available.

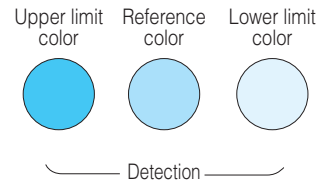

Teaching may be performed separately for more than one similar colors.

## Superior! Various teaching methods and differentiation functions

### • Manual teaching

Teaching with stationary work

- Single-point teaching provides accurate teaching for single color. Place work in the light spot and press the SET switch once.

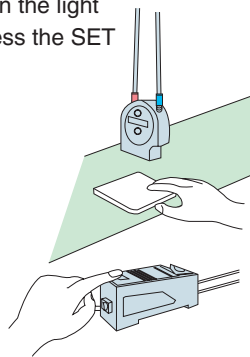

- Continuous teaching Teaching for wavy or unevenly-colored work Place work in the light spot and hold down the SET switch while manually moving the work so that all uneven areas pass through spot



### • Auto teaching

Teaching with moving work

- Single-push button teaching without stopping line Let the work pass while holding down SET switch.

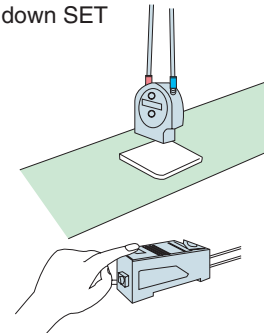

### • Differentiation

Accuracy and response speed (NML ↔ AVE)

- High response speed: 1 ms (NML)
- High-accuracy averaging: 5 ms (AVE)

Color component ratio and brightness (COL ↔ C + Y)

- Less influence of flapping of work (COL)
- Capable of fine color differentiation or differentiation between white and gray (C + Y)

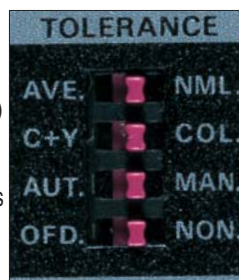

### • Data for 3 colors stored

3 color teaching + 3-bank changeover allowing selection of reference color with switch (\*)



### • Differentiation tolerance setting

Small tolerance value

Only color set by teaching detected (fine)

Large tolerance value

Colors similar to the color set by teaching are also detected (coarse)

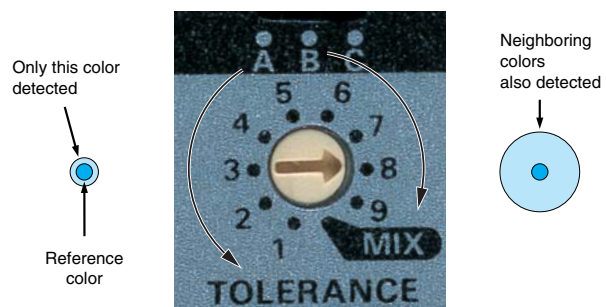

# CS-D3

## Rating/Performance/Specification/ Environmental specification

### • Amplifier

		LED color sensor amplifier		
		CS-D3	CS-D3PN	
Rating/performance	Type	LED color sensor amplifier		
	Model	CS-D3	CS-D3PN	
	Detection method	Time sharing spectrum measurement by red/green/blue LEDs		
	Power supply	12 – 24 VDC ±10% Ripple: 10 % max.		
	Power consumption	1.6 W max.		
	Response time	Normal (NML) mode: 1 ms max. Average value (AVE) mode: 5 ms max.		
	Control output	NPN open collector output	PNP open collector output	
	Output rating	Sink current 100 mA (30 VDC) max.	Source current 100 mA (30 VDC) max.	
	External input	No-voltage input: input duration 60 ms min.		
	Differentiation factor	COL (color component)/C + Y (color component and brightness)		
Teaching	Auto (AUT)/Manual (MAN)/Mix (MIX)			
Timer function	Time disabled (NON)/Off-delay OFD) about 50 ms			
Specification	Light source	Red, green, blue LEDs (RGB composition)		
	Light-sensitive element	Photodiode		
	Indicator	Power indicator (RUN):	yellow LED Illuminated while power is supplied, flashes during teaching	
		Operation indicator (OP.):	orange LED Illuminated when output is activated, flashes during mix teaching	
		Stability indicator (STB.):	green LED Illuminated for stable detection, flashes during auto teaching	
		Error indicator (ERR):	red LED Illuminated to indicate teaching error, flashes to indicate sensor failure	
	Protective feature	Output short circuit protection, power supply protection against reverse connection		
	Protective structure	IP 65 (with fiber optic cable attached)		
	Case material	Case: heat-resistant ABS / Cover: polycarbonate		
	Connection	Permanently attached cord (Outer dimension: dia.4.5) 0.2 mm <sup>2</sup> x 4 cores, 2 m		
	Mass	100 g max.		
	Accessory	1 mounting bracket, 1 screwdriver for setting, operation manual		
	Environmental specification	Ambient temperature	-10 - +55 °C (non-freezing)	
Ambient humidity		35-85%RH (non-condensing)		
Vibration		10-55 Hz / 1.5 mm amplitude / 2 hours each in 3 direction		
Shock		500 m/s <sup>2</sup> / 2 times each in 3 directions		
Dielectric withstanding		1,000 VAC for 1 minute		
Insulation resistance		500 VDC, 20 MΩ or higher		

### • Fiber optic cable

		Short range	Long range
		CS-DF10	CS-DF30
Rating/performance	Type	Short range	Long range
	Model	CS-DF10	CS-DF30
	Detection distance	13mm (10~16mm)	33mm (28~38mm)
	Fiber length	2 m (free-cutting)	
	Spot diameter (at detecting distance)	ø5mm max.	ø5mm max.
	Allowable bending radius	R 25 mm min.	
	Fiber	Core diameter: ø1.5 (receiver/transmitter)	
		Polyethylene cladding: ø2.2	
	Protective structure	IP 54 (optical part waterproofed)	
	Mass	40 g max.	50g max.
Accessory	1 fiber cutter		
Environmental specification	Ambient light	Illumination on light receiving surface: 5,000 lx max. for incandescent lamp, 10,000 max. for sunlight	
	Ambient temperature	-25 - +55 °C (non-freezing)	
	Ambient humidity	35-85%RH (non-condensing)	
	Vibration	10-55 Hz / 1.5 mm amplitude / 2 hours each in 3 direction	
	Shock	500 m/s <sup>2</sup> / 2 times each in 3 directions	

## Input/Output Circuit and Connection

Model CS-D3

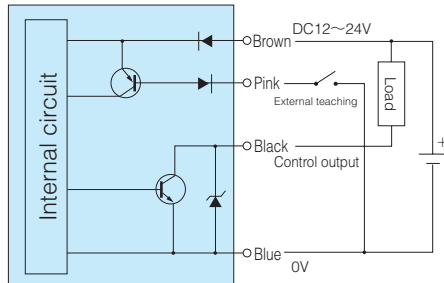

Model CS-D3PN

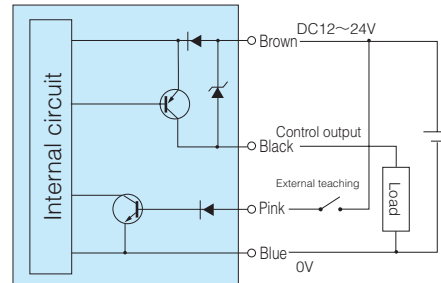

- With external teaching input, use “open collector” or “contact” input. The function is the same as that of the SET switch on the sensor main unit.
- The output circuit has a built-in short circuit protection circuit. For reset, deactivate the output once by turning the power back on or operating the “bank changeover switch.”

## Panel Layout and Functions

- **Mode selector switch**
  - AVE  $\leftrightarrow$  NML (detection accuracy)
    - NML: normal mode (1 ms)
    - AVE: average value mode (5 ms)
  - C + Y  $\leftrightarrow$  COL (color differentiation)
    - C + Y: color component and brightness determination
    - COL: color component and ratio determination
  - AUT  $\leftrightarrow$  MAN (teaching)
    - AUT: auto teaching
    - MAN: manual teaching
  - OFD  $\leftrightarrow$  NON (output timer)
    - OFD: 50 ms off-delay
    - NON: timer disabled

- **Indicator**
  - RUN : illuminated in normal operation, flashes during teaching
  - OP : operation indicator
  - STB : illuminated for stable detection
  - ERR : illuminated to indicate teaching error, flashes to indicate sensor failure
- **Bank changeover switch**
  - Data for 3 colors can be stored
- **Tolerance setting**
  - Tolerance with respect to the reference color
- **MIX**
  - Position for mix teaching
- **SET SW**
  - Teaching SET switch

# CS-D3

## Basic operation

When teaching is performed for the color to be detected, the upper and lower limits of the color differentiation according to the tolerance selector switch with reference to the stored reference color are set. If the received light intensity is within this range, the color is determined as a match. This basic operation is performed for red, green and blue and different calculations are applied according to the specified mode for output.

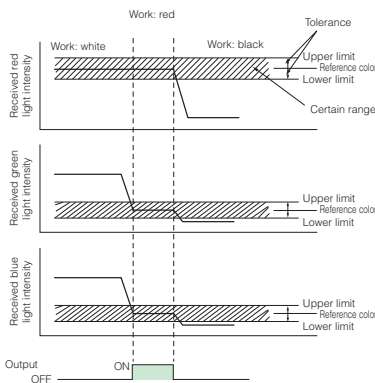

## Recommended operation mode

The following table shows recommended initial settings for the switches on the panel. Use appropriate setting according to the application.

High-speed mode	High-speed medium-performance mode	Medium-performance mode	High-performance mode
NML	NML	AVE	AVE
COL	C+Y	COL	C+Y
MAN	MAN	MAN	MAN
NON	NON	NON	NON

The tolerance switch can be set between 1 (finest differentiation level) and 9 (coarsest differentiation level). Start with 3 or 4. Recommended performance mode is the medium-performance mode. Test the operation using samples and select the most appropriate operation mode.

With intense black, only the reflectance can be differentiated therefore, detection may not succeed in some cases. Test the operation in the high performance mode.

## Teaching

For detecting red marks on the white background, teaching at the halfway point between the mark and background colors specifies composition of white and red (pink) as the reference color. The activation point is not at the center of a red mark but equivalent to the halfway point at which teaching has been performed.

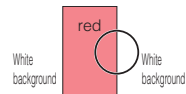

With this setting effective, pink region passing through the light spot while the work is moving generates faulty detection signal.

Similar faulty detection may occur with the halfway point with dark blue mark and blue and with green mark and yellow green. Teaching at the center of a pale color may also cause faulty detection signal at the halfway point between a color darker than the pale color and the background color. If many colors are expected to pass through the light spot, be sure to let all colors pass for testing the operation.

## Installation

Use the special mounting bracket or DIN rail.

### 1) Attachment

Put the guide lock of the amplifier on the DIN rail or mounting bracket and press in the direction of (2) while pressing forward (in the direction of (1)) to hook the front part.

### 2) Detachment

While pressing the amplifier forward (in the direction of (1)), lift in the direction of (3).

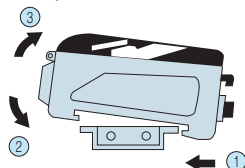

## Attachment of fiber optic cable to amplifier

- 1) Press the lever "down" in the direction of A
- 2) Insert the fiber with red tube into the opening marked with red and fiber with blue tube into the opening marked with blue. Press in all the way to the end.
- 3) Press the lever "down" in the direction of B until it stops.

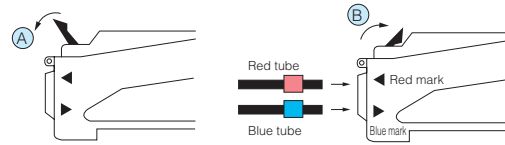

## Fiber optic cable installation

For installation of the fiber optic cables, the standard distance allows the most stable detection. However, the cables may be installed for use at distance ranges as shown below:

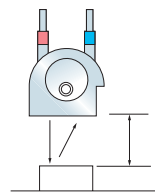

The tightening torque for installing CS-F10 and CS-DF30 should be up to 0.6 N·m.

### Guidelines for distance setting

<b>CS-DF30</b>	Standard distance: 33 mm/ Allowable range: 28-38 mm
<b>CS-DF10</b>	Standard distance: 13 mm/ Allowable range: 10-16 mm

## Hints on installation for glossy detection objects

- While the optical fiber is provided with a sufficient inclination in the receiver to avoid reflection from the surface of objects, especially glossy detected objects, install the head at an angle (10-15 degrees).

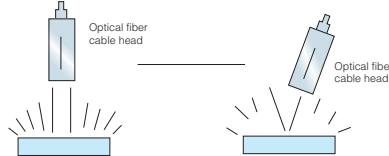

## Notes on usage

- Avoid use in which the power is turned on and off consecutively.
- When ambient temperature exceeds the specified operating temperature range, the RUN and ERR indicators are illuminated and detection stops.
- When ambient temperature is low at power-up, the RUN and ERR indicators are illuminated. This is because the temperature in the sensor is low. Wait with the power supplied to the sensor until the internal temperature rises sufficiently (about 10 minutes).
- Be sure to route the sensor lines separately from any power transmission or high-voltage line. Using the same conduit or duct for wiring may cause electric induction, which leads to faulty operation or damage.
- When using a switching regulator, be sure to connect the frame ground (FG) terminal. Failure to ground may cause faulty operation due to switching noise of the power supply.
- For cleaning the lens of a fiber optic cable, use a dry cloth, etc. and wipe gently (do not use organic solvent such as thinner or alcohol). Be sure to perform the teaching function again after cleaning.
- For waterproofing and preventing any accidental teaching, be sure to leave the cover on when using the sensor.
- Connect any unused input line with + V.
- Cutting the fiber reduces received light intensity and may make detection of dark colors less stable.
- For cutting fibers, use a new blade and limit it to a single use.
- The tightening torque for installing CS-DF10 and CS-DF30 should be up to 0.6 N·m.



## Dimensions (in mm)

Amplifier  
Model CS-D3  
Model CS-D3PN

CAD

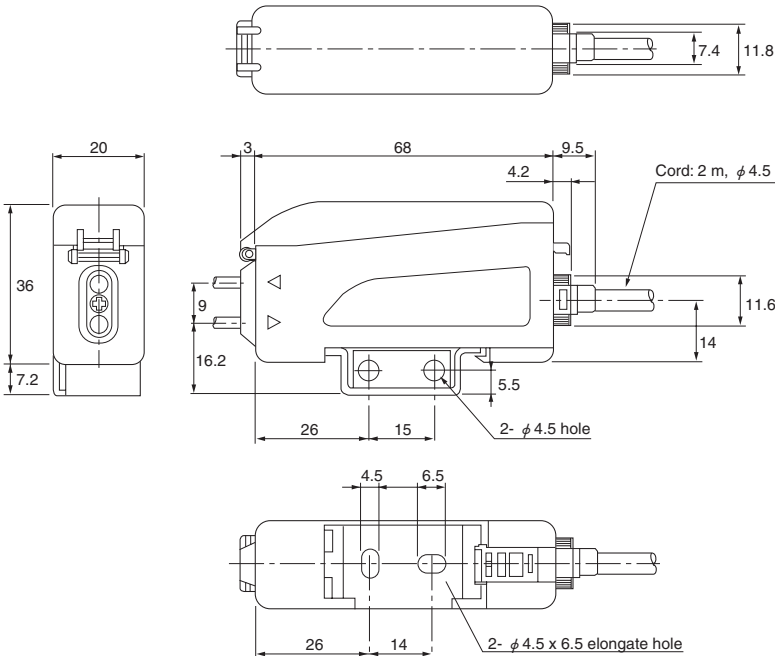

Optic fiber cable  
Model CS-DF10

CAD

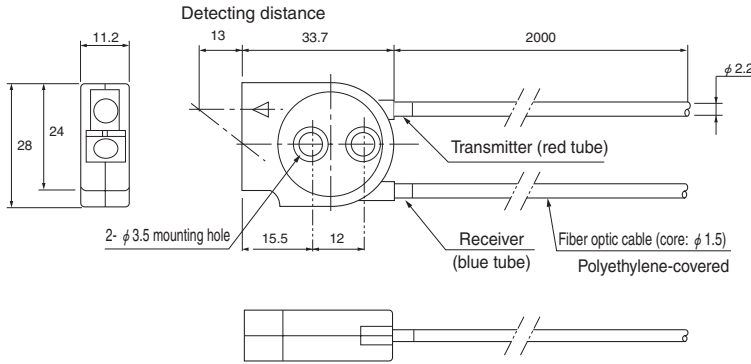

Model CS-DF30

CAD

